

Varenummer: 207321M141618ST  
Beskrivelse: E+G Pasbolt  
GN 732.1-M14-16-18-ST

## Mål

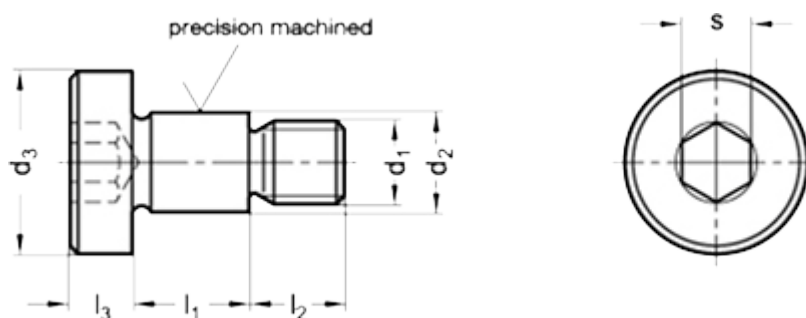

### Application example

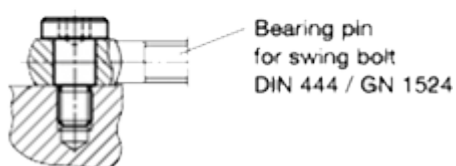

d1	= M 14
d2	= 16 -0.05/-0.08
d3	= 25
$l_1 +0.20/+0.13$	= 18
$l_2$	= 19
$l_3$	= 8
s	= 8
Vægt i (g)	= 51